

Bruger- og vedligeholdelsesmanual

CE

TUBO
the advanced
vacuum system.

Trådløst slangehåndtag

KCM187T

KCM184T



SUPPLIED COMPONENTS

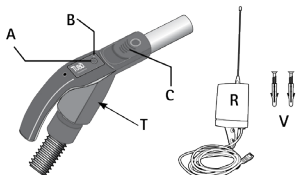

OPERATING FREQUENCY	433.92 Mhz
ACTUAL RADIO POWER	0.3mW
TYPE OF MODULATION	amplitude (ON OFF)
ABSORPTION DURING TRANSMISSION	10mA

- T - Wireless flexible tube
- A - start/stop button
- B - wireless signal LED
- C - pressure regulator
- D - depression detection tube
- R - appliance. Wireless receiver
- V - screws with plugs

COMPLIANCE WITH DIRECTIVE 99/05/EC

The remote control is compliant with the essential requirements provided by Directive 99/05/EC.

The following Technical Standards have been applied: EN 60335-1, EN 301489-3, EN 300220-3

BATTERY REPLACEMENT

The battery must be replaced when the light intensity of the LED (B) is low and the transmission range is significantly reduced.

- 1 - Open the cover using a screw-driver by undoing the 4 screws indicated by the arrows.
- 2 - Replace the battery inside (L) and close the cover.

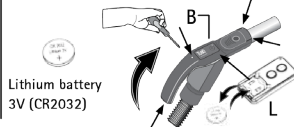

Lithium battery
3V (CR2032)

INSTALLATION

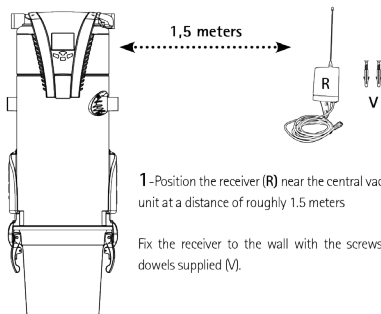

1-Position the receiver (R) near the central vacuum unit at a distance of roughly 1.5 meters

Fix the receiver to the wall with the screws and dowels supplied (V).

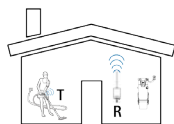

Inside a building, the operating range between the receiver (R) and the transmitter (T) is 15m, and it is capable of crossing two floors (S1 - S2)

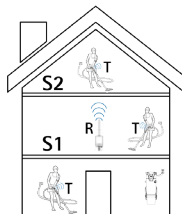

ATTENTION

If a house has several floors, we recommend installing the receiver on the middle floor.

The Receiver (R) cannot be installed outside the house.

WIRELESS CONNECTION

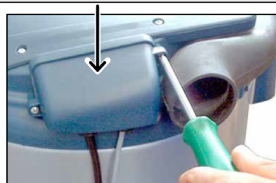

- 1 Open the power unit's electric connection casing

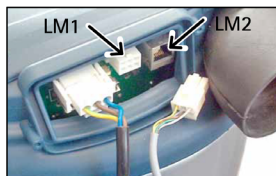

- 2 Disconnect the micro line connector LM1 and remove its cable with the wire press



- 3 Insert the new wireless cable and connect it to the dedicated LM2 plug inlet



- 4 Insert the wire press in the specific hole and close the casing.

WIRELESS AND MICRO LINE CONNECTION

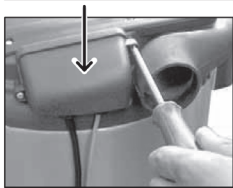

1 Open the power unit's electric connection casing.

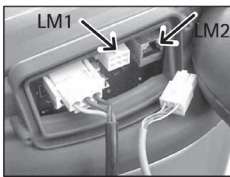

2 Disconnect the micro line connector LM1, remove the wire press from the hole and remove the cable.

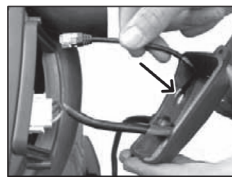

3 Insert the new wireless cable in the free hole and connect it to the dedicated LM2 plug inlet.

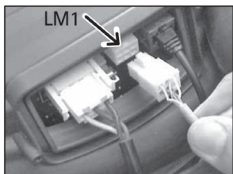

4 Reinsert the LM1 micro line connector into its dedicated inlet and insert the other cable end into the hole together with the one from the LM2 line.



5 Insert the endless end into the wire press where the wireless cable was already inserted.



6 Insert the wire press with both lines, LM1 and LM2, into the hole, close the casing and complete the connection to the socket line.

PROGRAMMING BETWEEN WIRELESS TUBE AND RECEIVER

THE PROGRAMMING BETWEEN THE WIRELESS TUBE AND THE RECEIVER IS ALREADY SET BY THE MANUFACTURER

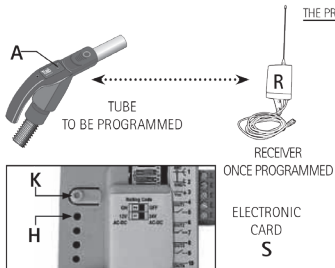

The central vacuum unit and the wireless receiver must remain connected to the power supply. The wireless receiver is powered by 12 volts so no electrical hazard risk exists.

- 1- check that the connection between the receiver plug line and the central vacuum unit is correct.
- 2- open the receiver (R).
- 3- remove the electronic card (S).
- 4- press the button (K), the LED will switch on (H).
- 5- press the start button (A) of the wireless tube within 5 seconds.
- 6- wait 5 seconds to complete the memorisation process
- 7- reinsert the electronic card and close the receiver (R).

The programming has been completed. The central vacuum unit will switch on and will switch off on each flexible hose.

DELETING SAVED PROGRAMMES

- 1 - disconnect the power line of the central power unit.
- 2 - open the receiver (R), remove the electronic card and press the button (K).
- 3 - while still pressing the button, reconnect the power to the unit.
- 4 - the LED (H) will switch on (red).
- 5 - release the button (K).
- 6 - when the LED (H) switches off, the memory on the card has been deleted.



Once the memory of the receiver (R) has been deleted, reprogram the wireless flexible tube by previous procedure.

HOW TO USE THE CLEANING ACCESSORIES

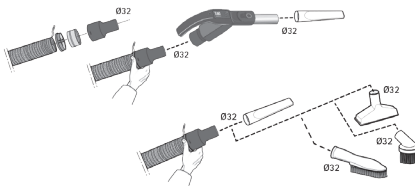

KRAPAN[®] KRAPPAN ApS
Langkær 50
6100 Haderslev
Tlf. 7022 9850
e-mail: info@krappan.com
www.krappan.com

TUBØ